

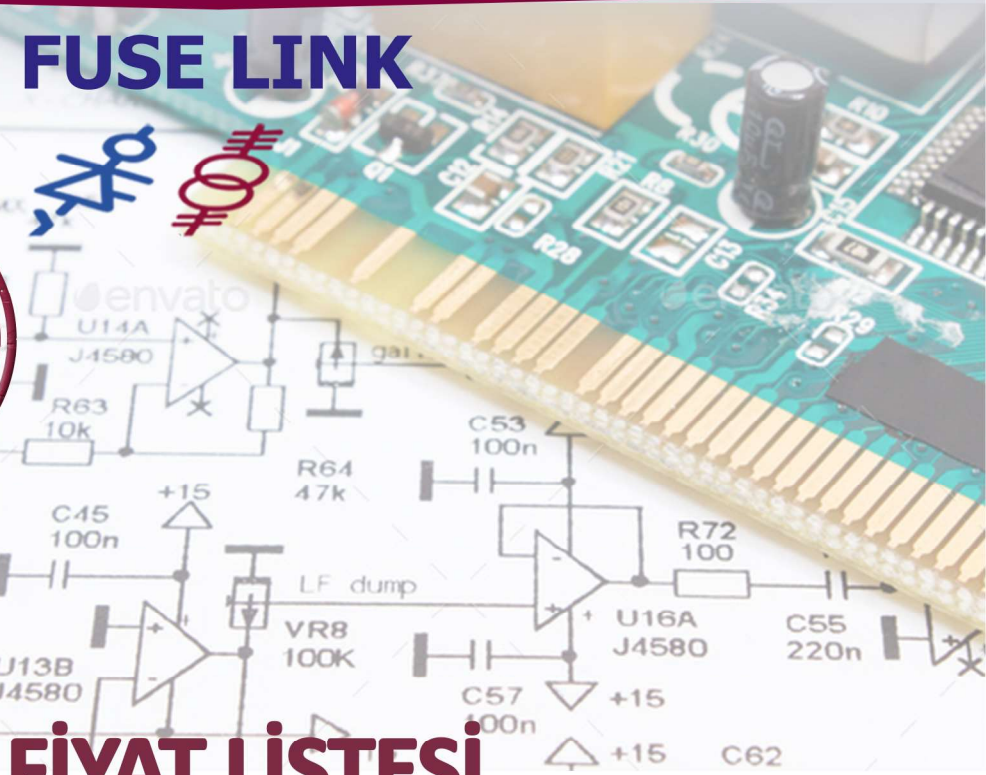

BOR®

FUSE LINK



FİYAT LİSTESİ

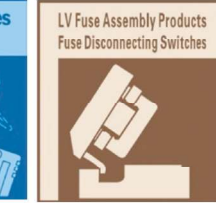
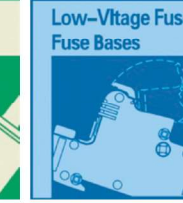
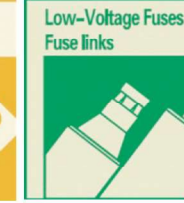
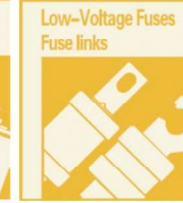
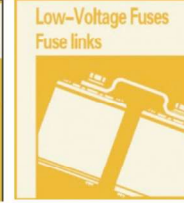
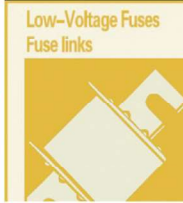
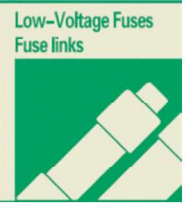

ST-type phase leg IGBT module

SISD0200ST120i20 200A 1200V

SISD0300ST120i20 300A 1200V

SISD0450ST120i20 450A 1200V

SISD0600ST120i20 600A 1200V

SISD0800ST120i20 800A 1200V



Çalışma Sıcaklığı: 175°C

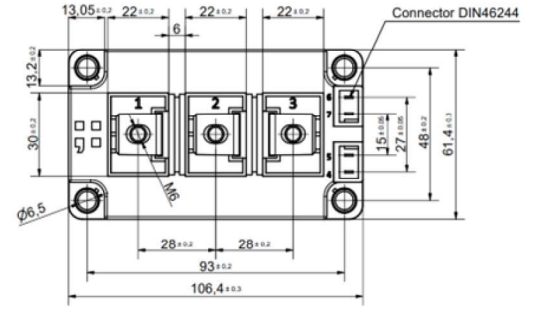
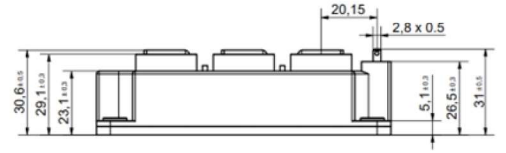

ED-type phase leg IGBT module

SISD0450ED120i20 450A 1200V

SISD0600ED120i20 600A 1200V

SISD0750ED120i20 750A 1200V



Çalışma Sıcaklığı: 175°C

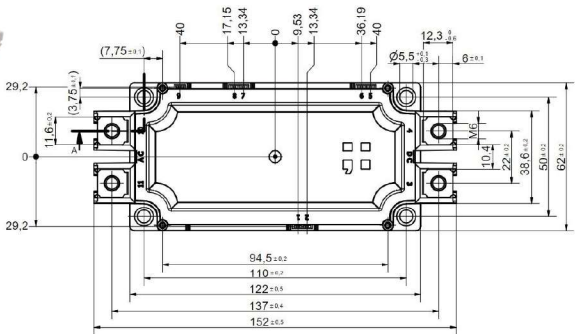
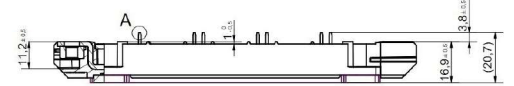

EP-type H-bridge IGBT power module with rectifier diode

SISP0200EP170i20 200A 1700V

SISP0150EP170i20 150A 1700V

SISP0100EP170i20 100A 1700V

SISP0075EP170i20 75A 1700V



Çalışma Sıcaklığı: 175°C

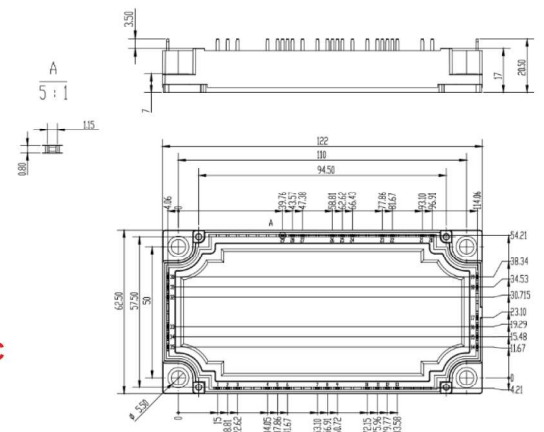

HEEV-type 1.2kV 2mOhm rdson phase-leg SiC module

HEEV phase leg SiC (Silisyum Karbür) modül



$V_{DSS} = 1200 V$
 $R_{Dson} = 2.1 m\Omega$
SCSD002HEEV120MS

EVD-Type three-phase 1.2kV SiC modül

Son nesil SiC (Silisyum Karbür) MOSFET çipleri
 $T_{vj_op} = 175^\circ C$

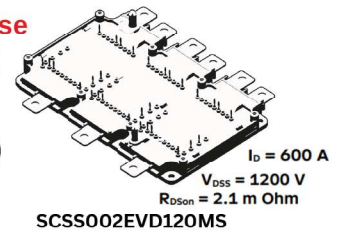

$I_b = 600 A$
 $V_{DSS} = 1200 V$
 $R_{Dson} = 2.1 m\Omega$
SCSS002EVD120MS

TRİSTÖR / TRİSTÖR - İZOLELİ GÜÇ MODÜLLERİ

1800V - 2200V

POWER MODULES

TYPE	IATV (A)	°C	VRRM(V)	CASE	B.Fiyat
HKKT 105/22E	105A	85	2200V	ADD A.PAK	55 \$
HKKT 136/22E	135A	85	2200V	INT A.PAK	97 \$
HKKT 162/22E	162A	85	2200V	INT A.PAK	110 \$
HKKT 250/22E	250A	85	2200V	MAGN A.PAK	185 \$
HKKT 320/22E	320A	85	2200V	MAGN A.PAK	200 \$
HKKT 330/22E	330A	85	2200V	MAGN A.PAK	240 \$
HKKT 500/22	500A	85	2200V	MEGA A.PAK	350 \$
HKKT 570/18	570A	85	1800V	MEGA A.PAK	380 \$
HKKT 800/22	800A	85	2200V	SUPER MEGA A.PAK	570 \$

TRİSTÖR/DİYOT-İZOLELİ GÜÇ MODÜLLERİ

TYPE	IATV (A)	°C	VRRM(V)	CASE	B.Fiyat
HKKH 105/22E	105A	85	2200V	ADD A.PAK	55 \$
HKKH 162/22E	162A	85	2200V	INT A.PAK	97 \$

VİDALI KAMÇILI DİYOTLAR

1000V - 1200V

TYPE	IATV (A)	°C	VRRM(V)	CASE	B.Fiyat
ZP 150UR 100	150A	125	1000V	DO-203 A A (DO-8) VİD.KAM.	30 \$
ZP 150U 100	150A	125	1000V	DO-203 A B (DO-8) VİD.KAM.	30 \$
ZP 400UR 120	400A	125	1200V	DO-205 A B (DO-9) VİD.KAM	55 \$
ZP 400U 120	400A	125	1200V	DO-205 A B (DO-9) VİD.KAM	55 \$

DİYOTLAR (DİSK TİPİ)

2000V

TYPE	IATV (A)	°C	VRRM(V)	CASE	B.Fiyat
HD1100A25	1400A	55	2000V	B-43 (E.PUK)	97 \$

DİYOTLAR (VİDALI TİP)

1200V

TYPE	IATV (A)	°C	VRRM(V)	CASE	B.Fiyat
40 HF 120	40A	140	1200V	DO-203 A B (DO-5) VİDALI	6 \$
40 HFR 120	40A	140	1200V	DO-203 A B (DO-5) VİDALI	6 \$
70 HF 120	70A	140	1200V	DO-203 A B (DO-5) VİDALI	7 \$
70 HFR 120	70A	140	1200V	DO-203 A B (DO-5) VİDALI	7 \$

TRİFAZE KÖPRÜ DİYOTLAR

1600V

TYPE	IATV (A)	°C	VRRM(V)	CASE	B.Fiyat
H36MT 160	36A	60	1600V	D.63	9 \$
H36MB 160	36A	60	1600V	D.63	9 \$

MONOFAZE KÖPRÜ DİYOTLAR

1600V

TYPE	IATV (A)	°C	VRRM(V)	CASE	B.Fiyat
HBPC3512A	36A	60	1600V	D.34	4,50 \$

B.Fiyat

ÇAKMA DİYOTLAR

1200V

TYPE	IATV (A)	VRRM(V)	B.Fiyat
ANOT	60A	1200V	3 \$
KATOT	60A	1200V	3 \$



FUSE LINK

MRO BOR

(D01) gG (Neozed) Sigortalar

Sipariş Kodu	Boy	Voltaj (V)	Akım (A)	B.Fiyat
RO26 400V 2A gG	D01	400V	2A	0,90 USD
RO26 400V 4A gG	D01	400V	4A	0,90 USD
RO26 400V 6A gG	D01	400V	6A	0,90 USD
RO26 400V 10A gG	D01	400V	10A	0,90 USD
RO26 400V 16A gG	D01	400V	16A	0,90 USD

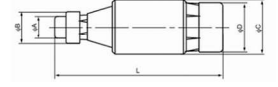

MRO BOR

(D02) gG (Neozed) Sigortalar

Sipariş Kodu	Boy	Voltaj (V)	Akım (A)	B.Fiyat
RO26 400V 20A gG	DO2	400V	20A	1,20 USD
RO26 400V 25A gG	DO2	400V	25A	1,20 USD
RO26 400V 35A gG	DO2	400V	35A	1,20 USD
RO26 400V 50A gG	DO2	400V	50A	1,20 USD
RO26 400V 63A gG	DO2	400V	63A	1,20 USD

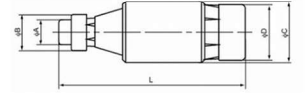

MRO BOR

(D01) aR (Neozed) Sigortalar (Hızlı Tip)

Sipariş Kodu	Boy	Voltaj (V)	Akım (A)	B.Fiyat
RS26 400V 2A aR	D01	400V	2A	4,50 USD
RS26 400V 4A aR	D01	400V	4A	4,50 USD
RS26 400V 6A aR	D01	400V	6A	4,50 USD
RS26 400V 10A aR	D01	400V	10A	4,50 USD
RS26 400V 16A aR	D01	400V	16A	4,50 USD

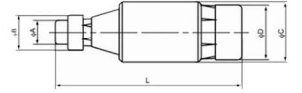

MRO BOR

(D02) aR (Neozed) Sigortalar (Hızlı Tip)

Sipariş Kodu	Boy	Voltaj (V)	Akım (A)	B.Fiyat
RS26 400V 20A aR	D02	400V	20A	5,00 USD
RS26 400V 25A aR	D02	400V	25A	5,00 USD
RS26 400V 35A aR	D02	400V	35A	5,00 USD
RS26 400V 50A aR	D02	400V	50A	5,00 USD
RS26 400V 63A aR	D02	400V	63A	5,00 USD

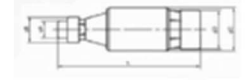

MRO BOR

(DII) gG (Diazed) Sigortalar (RO21)

Sipariş Kodu	Boy	Voltaj (V)	Akım (A)	B.Fiyat
RL6-25 500V 2A gG	DII	500V	2A	1,40 USD
RL6-25 500V 4A gG	DII	500V	4A	1,40 USD
RL6-25 500V 6A gG	DII	500V	6A	1,40 USD
RL6-25 500V 10A gG	DII	500V	10A	1,40 USD
RL6-25 500V 16A gG	DII	500V	16A	1,40 USD
RL6-25 500V 20A gG	DII	500V	20A	1,40 USD
RL6-25 500V 25A gG	DII	500V	25A	1,40 USD

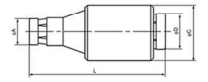

MRO BOR

(DIII) gG (Diazed) Sigortalar (RO22)

Sipariş Kodu	Boy	Voltaj (V)	Akım (A)	B.Fiyat
RL6-63 500V 35A gG	DIII	500V	35A	2,00 USD
RL6-63 500V 50A gG	DIII	500V	50A	2,00 USD
RL6-63 500V 63A gG	DIII	500V	63A	2,00 USD

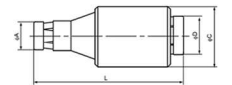

MRO BOR

(DIII) aR (Diazed) Sigortalar (RS22)

Sipariş Kodu	Boy	Voltaj (V)	Akım (A)	B.Fiyat
RL6-63 500V 35A gG aR	DIII	500V	35A	9,50 USD
RL6-63 500V 50A gG aR	DIII	500V	50A	9,50 USD
RL6-63 500V 63A gG aR	DIII	500V	63A	9,50 USD

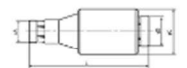

MRO BOR

8x32 gG Gecikmeli/Silindirik Sigortalar

Sipariş Kodu	Boy	Voltaj (V)	Akım (A)	B.Fiyat
RO14 500V 1A gG	8x32	500V	1A	1,00 USD
RO14 500V 2A gG	8x32	500V	2A	1,00 USD
RO14 500V 4A gG	8x32	500V	4A	1,00 USD
RO14 500V 6A gG	8x32	500V	6A	1,00 USD
RO14 500V 8A gG	8x32	500V	8A	1,00 USD
RO14 500V 10A gG	8x32	500V	10A	1,00 USD
RO14 500V 12A gG	8x32	500V	12A	1,00 USD
RO14 500V 16A gG	8x32	500V	16A	1,00 USD
RO14 500V 20A gG	8x32	500V	20A	1,00 USD



Sipariş Kodu	Boy	Voltaj (V)	Akım (A)	B.Fiyat
RO15 500V 0,5A gG	10x38	500V	0,5A	1,00 USD
RO15 500V 1A gG	10x38	500V	1A	1,00 USD
RO15 500V 2A gG	10x38	500V	2A	1,00 USD
RO15 500V 4A gG	10x38	500V	4A	1,00 USD
RO15 500V 6A gG	10x38	500V	6A	1,00 USD
RO15 500V 8A gG	10x38	500V	8A	1,00 USD
RO15 500V 10A gG	10x38	500V	10A	1,00 USD
RO15 500V 12A gG	10x38	500V	12A	1,00 USD
RO15 500V 16A gG	10x38	500V	16A	1,00 USD
RO15 500V 20A gG	10x38	500V	20A	1,00 USD
RO15 500V 25A gG	10x38	500V	25A	1,00 USD
RO15 500V 32A gG	10x38	500V	32A	1,00 USD

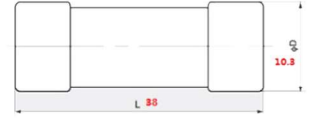

Sipariş Kodu	Boy	Voltaj (V)	Akım (A)	B.Fiyat
RO15 500V 2A aM	10x38	500V	2A	1,00 USD
RO15 500V 4A aM	10x38	500V	4A	1,00 USD
RO15 500V 6A aM	10x38	500V	6A	1,00 USD
RO15 500V 8A aM	10x38	500V	8A	1,00 USD
RO15 500V 10A aM	10x38	500V	10A	1,00 USD
RO15 500V 12A aM	10x38	500V	12A	1,00 USD
RO15 500V 16A aM	10x38	500V	16A	1,00 USD
RO15 500V 20A aM	10x38	500V	20A	1,00 USD
RO15 500V 25A aM	10x38	500V	25A	1,00 USD
RO15 500V 32A aM	10x38	500V	32A	1,00 USD



Sipariş Kodu	Boy	Voltaj (V)	Akım (A)	B.Fiyat
RO16 500V 2A gG	14x51	500V	2A	2,50 USD
RO16 500V 4A gG	14x51	500V	4A	2,50 USD
RO16 500V 6A gG	14x51	500V	6A	2,50 USD
RO16 500V 8A gG	14x51	500V	8A	2,50 USD
RO16 500V 10A gG	14x51	500V	10A	2,50 USD
RO16 690V 16A gG	14x51	690V	16A	2,50 USD
RO16 690V 20A gG	14x51	690V	20A	2,50 USD
RO16 690V 25A gG	14x51	690V	25A	2,50 USD
RO16 690V 32A gG	14x51	690V	32A	2,50 USD
RO16 500V 40A gG	14x51	500V	40A	2,50 USD
RO16 400V 50A gG	14x51	400V	50A	2,50 USD
RO16 500V 63A gG	14x51	500V	63A	4,50 USD

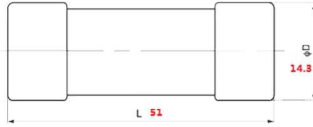

Sipariş Kodu	Boy	Voltaj (V)	Akım (A)	B.Fiyat
RO17 500V 2A	22x58	500V	2A	4,50 USD
RO17 500V 4A	22x58	500V	4A	4,50 USD
RO17 500V 6A	22x58	500V	6A	4,50 USD
RO17 500V 8A	22x58	500V	8A	4,50 USD
RO17 500V 10A	22x58	500V	10A	4,50 USD
RO17 500V 12A	22x58	500V	12A	4,50 USD
RO17 500V 16A	22x58	500V	16A	4,50 USD
RO17 500V 20A	22x58	500V	20A	4,00 USD
RO17 500V 25A	22x58	500V	25A	4,00 USD
RO17 500V 32A	22x58	500V	32A	4,00 USD
RO17 500V 40A	22x58	500V	40A	4,00 USD
RO17 500V 50A	22x58	500V	50A	4,00 USD
RO17 500V 63A	22x58	500V	63A	4,00 USD
RO17 500V 80A	22x58	500V	80A	4,00 USD
RO17 500V 100A	22x58	500V	100A	4,00 USD
RO17 500V 125A	22x58	500V	125A	4,00 USD

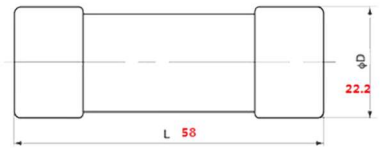

Sipariş Kodu	Boy	Voltaj (V)	Akım (A)	B.Fiyat
RS15 690V 1A aR	10x38	690V	1A	4,00 USD
RS15 690V 2A aR	10x38	690V	2A	4,00 USD
RS15 690V 3A aR	10x38	690V	3A	4,00 USD
RS15 690V 4A aR	10x38	690V	4A	4,00 USD
RS15 690V 5A aR	10x38	690V	5A	4,00 USD
RS15 690V 6A aR	10x38	690V	6A	4,00 USD
RS15 690V 8A aR	10x38	690V	8A	4,00 USD
RS15 690V 10A aR	10x38	690V	10A	4,00 USD
RS15 690V 12A aR	10x38	690V	12A	4,00 USD
RS15 690V 16A aR	10x38	690V	16A	5,00 USD
RS15 690V 20A aR	10x38	690V	20A	5,00 USD
RS15 690V 25A aR	10x38	690V	25A	5,00 USD
RS15 690V 30A aR	10x38	690V	30A	5,00 USD
RS15 690V 32A aR	10x38	690V	32A	5,00 USD

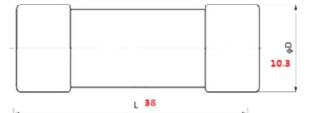

Sipariş Kodu	Boy	Voltaj (V)	Akım (A)	B.Fiyat
RS16 690V 2A aR	14x51	690V	2A	8,00 USD
RS16 690V 4A aR	14x51	690V	4A	8,00 USD
RS16 690V 6A aR	14x51	690V	6A	8,00 USD
RS16 690V 8A aR	14x51	690V	8A	8,00 USD
RS16 690V 10A aR	14x51	690V	10A	8,00 USD
RS16 690V 16A aR	14x51	690V	16A	8,00 USD
RS16 690V 20A aR	14x51	690V	20A	8,00 USD
RS16 690V 25A aR	14x51	690V	25A	8,00 USD
RS16 690V 32A aR	14x51	690V	32A	8,00 USD
RS16 690V 40A aR	14x51	690V	40A	8,00 USD
RS16 690V 50A aR	14x51	690V	50A	8,00 USD
RS16 690V 63A aR	14x51	690V	63A	10,00 USD

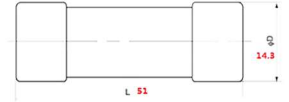

14x51 mm aR Hızlı İndikatörlü Silindirik Porselen Sigortalar

Sipariş Kodu	Boy	Voltaj (V)	Akım (A)	B.Fiyat
RS16Z 690V 8A aR	14x51mm İndikatörlü	690V	8A	10,00 USD
RS16Z 690V 16A aR	14x51mm İndikatörlü	690V	16A	10,00 USD
RS16Z 690V 20A aR	14x51mm İndikatörlü	690V	20A	10,00 USD
RS16Z 690V 25A aR	14x51mm İndikatörlü	690V	25A	10,00 USD
RS16Z 690V 32A aR	14x51mm İndikatörlü	690V	32A	10,00 USD
RS16Z 690V 40A aR	14x51mm İndikatörlü	690V	40A	10,00 USD
RS16Z 690V 50A aR	14x51mm İndikatörlü	690V	50A	10,00 USD



22x58 mm Hızlı aR İndikatörlü Silindirik Porselen Sigortalar

Sipariş Kodu	Boy	Voltaj (V)	Akım (A)	B.Fiyat
RS17Z 690V 10A aR	22x58 İndikatörlü	690V	10A	15,00 USD
RS17Z 690V 16A aR	22x58 İndikatörlü	690V	16A	15,00 USD
RS17Z 690V 20A aR	22x58 İndikatörlü	690V	20A	15,00 USD
RS17Z 690V 25A aR	22x58 İndikatörlü	690V	25A	15,00 USD
RS17Z 690V 32A aR	22x58 İndikatörlü	690V	32A	15,00 USD
RS17Z 690V 40A aR	22x58 İndikatörlü	690V	40A	15,00 USD
RS17Z 690V 50A aR	22x58 İndikatörlü	690V	50A	15,00 USD
RS17Z 690V 63A aR	22x58 İndikatörlü	690V	63A	15,00 USD
RS17Z 690V 80A aR	22x58 İndikatörlü	690V	80A	15,00 USD
RS17Z 690V 100A aR	22x58 İndikatörlü	690V	100A	15,00 USD
RS17Z 690V 125A aR	22x58 İndikatörlü	690V	125A	15,00 USD



27x60 mm Hızlı aR İndikatörlü Silindirik Porselen Sigortalar

Sipariş Kodu	Boy	Voltaj (V)	Akım (A)	B.Fiyat
RS12Z 690V 6A aR	27x60/6	690V	6A	30,00 USD
RS12Z 690V 8A aR	27x60/8	690V	8A	30,00 USD
RS12Z 690V 10A aR	27x60/10	690V	10A	30,00 USD
RS12Z 690V 12A aR	27x60/12	690V	12A	30,00 USD
RS12Z 690V 16A aR	27x60/16	690V	16A	30,00 USD
RS12Z 690V 20A aR	27x60/20	690V	20A	30,00 USD
RS12Z 690V 25A aR	27x60/25	690V	25A	30,00 USD
RS12Z 690V 32A aR	27x60/32	690V	32A	30,00 USD
RS12Z 690V 40A aR	27x60/40	690V	40A	30,00 USD
RS12Z 690V 50A aR	27x60/50	690V	50A	30,00 USD
RS12Z 690V 63A aR	27x60/63	690V	63A	30,00 USD
RS12Z 690V 80A aR	27x60/80	690V	80A	30,00 USD
RS12Z 690V 100A aR	27x60/100	690V	100A	35,00 USD
RS12Z 690V 125A aR	27x60/125	690V	125A	35,00 USD
RS12Z 690V 160A aR	27x60/160	690V	160A	35,00 USD
RS12Z 690V 200A aR	27x60/200	690V	200A	35,00 USD
RS12Z 690V 250A aR	27x60/250	690V	250A	35,00 USD

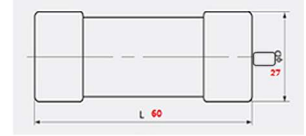

(DC) 27x60 mm aR İndikatörlü Silindirik Porselen Sigortalar

Sipariş Kodu	Boy	Voltaj (V)	Akım (A)	B.Fiyat
RS12ZVDC 660V 12A aR	27x60 mm İndikatörlü	660VDC	12A	70,00 USD
RS12ZVDC 660V 16A aR	27x60 mm İndikatörlü	660VDC	16A	70,00 USD
RS12ZVDC 660V 20A aR	27x60 mm İndikatörlü	660VDC	20A	70,00 USD
RS12ZVDC 660V 25A aR	27x60 mm İndikatörlü	660VDC	25A	70,00 USD
RS12ZVDC 660V 50A aR	27x60 mm İndikatörlü	660VDC	50A	70,00 USD



20x127mm AR 1000VDC İndikatörlü Silindirik Porselen Sigortalar

Sipariş Kodu	Boy	Voltaj (V)	Akım (A)	B.Fiyat
RS19ZDC 1500VDC 2A aR	20x127/2	1500V DC	2A	165,00 USD
RS19ZDC 1000VDC 2A aR	20x127/2	1000V DC	2A	165,00 USD
RS19ZDC 1000VDC 16A aR	20x127/16	1000V DC	16A	125,00 USD
RS19ZDC 1000VDC 20A aR	20x127/20	1000V DC	20A	125,00 USD
RS19ZDC 1000VDC 25A aR	20x127/25	1000V DC	25A	125,00 USD
RS19ZDC 1000VDC 32A aR	20x127/32	1000V DC	32A	125,00 USD
RS19ZDC 1000VDC 40A aR	20x127/40	1000V DC	40A	180,00 USD
RS19ZDC 1000VDC 50A aR	20x127/50	1000V DC	50A	225,00 USD



20x127 mm

Teslimat Süreli

20x127 mm aR İndikatörlü Silindirik Porselen Sigortalar

Sipariş Kodu	Boy	Voltaj (V)	Akım (A)	B.Fiyat
RS19Z 1500V 2A aR	20x127/2	1500V AC	2A	65,00 USD
RS19Z 1500V 16A aR	20x127/16	1500V AC	16A	30,00 USD
RS19Z 1500V 20A aR	20x127/20	1500V AC	20A	30,00 USD
RS19Z 1500V 25A aR	20x127/25	1500V AC	25A	30,00 USD
RS19Z 1500V 32A aR	20x127/32	1500V AC	32A	30,00 USD
RS19Z 1500V 40A aR	20x127/40	1500V AC	40A	65,00 USD
RS19Z 1500V 50A aR	20x127/50	1500V AC	50A	85,00 USD



20x127 mm

Sipariş Kodu	Boy	Voltaj (V)	Akım (A)	B.Fiyat
RGS11 250V 25A aR	17/25	250V	25A	9,00 USD
RGS11 250V 35A aR	17/35	250V	35A	9,00 USD
RGS11 250V 50A aR	17/50	250V	50A	9,00 USD
RGS11 250V 63A aR	17/63	250V	63A	9,00 USD
RGS11 250V 80A aR	17/80	250V	80A	9,00 USD
RGS11 250V 100A aR	17/100	250V	100A	9,00 USD
RGS11 250V 125A aR	21/125	250V	125A	15,00 USD
RGS11 250V 140A aR	21/140	250V	140A	15,00 USD
RGS11 250V 160A aR	21/160	250V	160A	15,00 USD
RGS11 250V 180A aR	21/180	250V	180A	15,00 USD

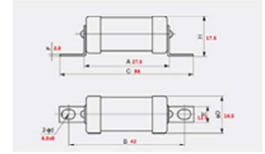

Sipariş Kodu	Boy	Voltaj (V)	Akım (A)	B.Fiyat
RGS12 500V 135A aR	31.5/27	500V	135A	32,00 USD
RGS4A 690V 125A aR	25/125	690V	125A	35,00 USD
RGS4A 690V 160A aR	25/160	690V	160A	50,00 USD
RGS4A 690V 180A aR	25/180	690V	180A	55,00 USD
RGS4A 690V 200A aR	25/200	690V	200A	55,00 USD

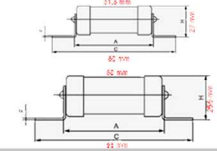

Sipariş Kodu	Boy	Voltaj (V)	Akım (A)	B.Fiyat
RGS4 690V 20A aR	17/20	690V	20A	9,00 USD
RGS4 690V 25A aR	17/25	690V	25A	9,00 USD
RGS4 690V 35A aR	17/35	690V	35A	9,00 USD
RGS4 690V 40A aR	17/40	690V	40A	9,00 USD
RGS4 690V 45A aR	17/45	690V	45A	9,00 USD
RGS4 690V 50A aR	17/50	690V	50A	9,00 USD
RGS4 690V 63A aR	17/63	690V	63A	9,00 USD
RGS4 690V 80A aR	17/80	690V	80A	9,00 USD
RGS4 690V 100A aR	17/100	690V	100A	9,00 USD

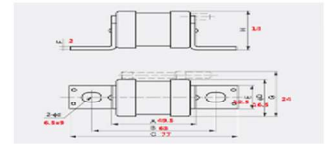

Sipariş Kodu	Boy	Voltaj (V)	Akım (A)	B.Fiyat
RGS44 690V 110A aR	217/110	690V	110A	18,00 USD
RGS44 690V 140A aR	217/140	690V	140A	18,00 USD
RGS44 690V 160A aR	217/160	690V	160A	18,00 USD

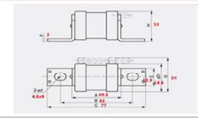

Sipariş Kodu	Boy	Voltaj (V)	Akım (A)	B.Fiyat
RS30C 690V 16A aR	NH000 C	690V	16A	19,00 USD
RS30C 690V 20A aR	NH000 C	690V	20A	19,00 USD
RS30C 690V 25A aR	NH000 C	690V	25A	19,00 USD
RS30C 690V 32A aR	NH000 C	690V	32A	19,00 USD
RS30C 690V 40A aR	NH000 C	690V	40A	19,00 USD
RS30C 690V 50A aR	NH000 C	690V	50A	19,00 USD
RS30C 690V 63A aR	NH000 C	690V	63A	19,00 USD
RS30C 690V 80A aR	NH000 C	690V	80A	19,00 USD
RS30C 690V 100A aR	NH000 C	690V	100A	19,00 USD
RS30C 690V 125A aR	NH000 C	690V	125A	19,00 USD
RS30C 690V 160A aR	NH000 C	690V	160A	19,00 USD
RS30C 690V 200A aR	NH000 C	690V	200A	20,00 USD
RS30C 690V 250A aR	NH000 C	690V	250A	20,00 USD
RS30C 690V 315A aR	NH000 C	690V	315A	20,00 USD

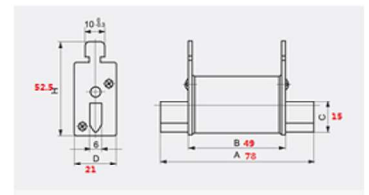

Sipariş Kodu	Boy	Voltaj (V)	Akım (A)	B.Fiyat
RS31 690V 20A aR	NH00	690V	20A	19,00 USD
RS31 690V 25A aR	NH00	690V	25A	19,00 USD
RS31 690V 32A aR	NH00	690V	32A	19,00 USD
RS31 690V 40A aR	NH00	690V	40A	19,00 USD
RS31 690V 50A aR	NH00	690V	50A	19,00 USD
RS31 690V 63A aR	NH00	690V	63A	19,00 USD
RS31 690V 80A aR	NH00	690V	80A	19,00 USD
RS31 690V 100A aR	NH00	690V	100A	19,00 USD
RS31 690V 125A aR	NH00	690V	125A	19,00 USD
RS31 690V 160A aR	NH00	690V	160A	19,00 USD

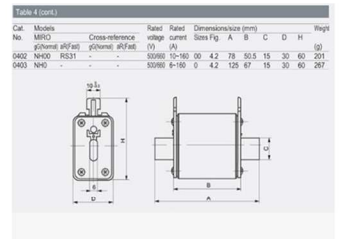

NH1 Boy Hızlı Sigortalar aR

Sipariş Kodu	Boy	Voltaj (V)	Akım (A)	B.Fiyat
RS32 690V 100A aR	NH1	690V	100A	36,00 USD
RS32 690V 125A aR	NH1	690V	125A	36,00 USD
RS32 690V 160A aR	NH1	690V	160A	36,00 USD
RS32 690V 200A aR	NH1	690V	200A	36,00 USD
RS32 690V 250A aR	NH1	690V	250A	36,00 USD
RS32 690V 315A aR	NH1	690V	315A	40,00 USD
RS32 690V 350A aR	NH1	690V	350A	40,00 USD
RS32 690V 400A aR	NH1	690V	400A	40,00 USD



Car. Modeli	Cross-reference	Rated voltage	Rated current	Rated I ² t	Dimensions (mm)	Weight
No.	MRO	(V)	(A)	(s)	Size Fig. A B C D H	(g)
040A	NH1	RS32	-	50000	3-2-20	4.3 130 67 20 46 58.5 447
040A	NH2	RS33	-	50000	3-2-20	4.3 130 67 20 46 58.5 447
040A	NH3	RS34	-	50000	3-2-20	4.3 130 67 20 46 58.5 447
040A	NH3	RS34	-	50000	3-2-20	4.3 130 67 20 46 58.5 447

NH2 Boy Hızlı Sigortalar aR

Sipariş Kodu	Boy	Voltaj (V)	Akım (A)	B.Fiyat
RS33 690V 250A aR	NH2	690V	250A	50,00 USD
RS33 690V 315A aR	NH2	690V	315A	50,00 USD
RS33 690V 350A aR	NH2	690V	350A	50,00 USD
RS33 690V 400A aR	NH2	690V	400A	50,00 USD
RS33 690V 450A aR	NH2	690V	450A	50,00 USD
RS33 690V 500A aR	NH2	690V	500A	55,00 USD
RS33 690V 550A aR	NH2	690V	550A	55,00 USD
RS33 690V 630A aR	NH2	690V	630A	55,00 USD
RS33 690V 700A aR	NH2	690V	700A	55,00 USD



Car. Modeli	Cross-reference	Rated voltage	Rated current	Rated I ² t	Dimensions (mm)	Weight
No.	MRO	(V)	(A)	(s)	Size Fig. A B C D H	(g)
040A	NH1	RS32	-	50000	3-2-20	4.3 130 67 20 46 58.5 447
040A	NH2	RS33	-	50000	3-2-20	4.3 130 67 20 46 58.5 447
040A	NH3	RS34	-	50000	3-2-20	4.3 130 67 20 46 58.5 447
040A	NH3	RS34	-	50000	3-2-20	4.3 130 67 20 46 58.5 447

NH3 Boy Hızlı Sigortalar aR

Sipariş Kodu	Boy	Voltaj (V)	Akım (A)	B.Fiyat
RS34 690V 500A aR	NH3	690V	500A	105,00 USD
RS34 690V 550A aR	NH3	690V	550A	105,00 USD
RS34 690V 630A aR	NH3	690V	630A	105,00 USD
RS34 690V 700A aR	NH3	690V	700A	135,00 USD
RS34 690V 800A aR	NH3	690V	800A	135,00 USD
RS34 690V 900A aR	NH3	690V	900A	135,00 USD
RS34 690V 1000A aR	NH3	690V	1000A	150,00 USD
RS34 690V 1100A aR	NH3	690V	1100A	150,00 USD
RS34 690V 1250A aR	NH3	690V	1250A	150,00 USD
RS34 690V 1400A aR	NH3	690V	1400A	150,00 USD
RS34 RSMZ301966	NH3	1100V	800A	195,00 USD
RS34 1000V 1000A aR	NH3	1000V	1000A	200,00 USD



Z301966

Car. Modeli	Cross-reference	Rated voltage	Rated current	Rated I ² t	Dimensions (mm)	Weight
No.	MRO	(V)	(A)	(s)	Size Fig. A B C D H	(g)
040A	NH1	RS32	-	50000	3-2-20	4.3 130 67 20 46 58.5 447
040A	NH2	RS33	-	50000	3-2-20	4.3 130 67 20 46 58.5 447
040A	NH3	RS34	-	50000	3-2-20	4.3 130 67 20 46 58.5 447
040A	NH3	RS34	-	50000	3-2-20	4.3 130 67 20 46 58.5 447

aR L Bracket Yere Montaj NH000 Hızlı Yarı İletken Koruma Sigortaları

Sipariş Kodu	Boy	Voltaj (V)	Akım (A)	B.Fiyat
RGS30AQ 690V 16A aR	NH.000.L	690V	16A	25,00 USD
RGS30AQ 690V 20A aR	NH.000.L	690V	20A	25,00 USD
RGS30AQ 690V 25A aR	NH.000.L	690V	25A	25,00 USD
RGS30AQ 690V 32A aR	NH.000.L	690V	32A	25,00 USD
RGS30AQ 690V 40A aR	NH.000.L	690V	40A	25,00 USD
RGS30AQ 690V 50A aR	NH.000.L	690V	50A	25,00 USD
RGS30AQ 690V 63A aR	NH.000.L	690V	63A	25,00 USD
RGS30AQ 690V 80A aR	NH.000.L	690V	80A	25,00 USD
RGS30AQ 690V 100A aR	NH.000.L	690V	100A	25,00 USD
RGS30AQ 690V 125A aR	NH.000.L	690V	125A	27,00 USD
RGS30AQ 690V 160A aR	NH.000.L	690V	160A	27,00 USD
RGS30AQ 690V 200A aR	NH.000.L	690V	200A	29,00 USD
RGS30AQ 690V 250A aR	NH.000.L	690V	250A	29,00 USD
RGS30AQ 690V 315A aR	NH.000.L	690V	315A	29,00 USD

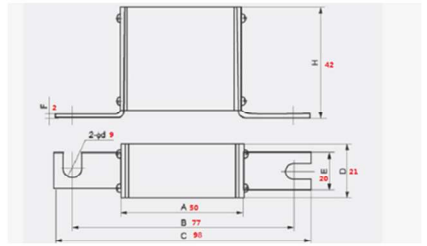

aR L Bracket Yere Montaj NH00 Hızlı Yarı İletken Koruma Sigortaları

Sipariş Kodu	Boy	Voltaj (V)	Akım (A)	B.Fiyat
RS711B 690V 100A aR	NH.00.L	690V	100A	35,00 USD
RS711B 690V 125A aR	NH.00.L	690V	125A	35,00 USD
RS711B 690V 160A aR	NH.00.L	690V	160A	35,00 USD
RS711B 690V 200A aR	NH.00.L	690V	200A	35,00 USD
RS711B 690V 250A aR	NH.00.L	690V	250A	35,00 USD
RS711B 690V 315A aR	NH.00.L	690V	315A	35,00 USD
RS711B 690V 350A aR	NH.00.L	690V	350A	35,00 USD
RS711B 690V 400A aR	NH.00.L	690V	400A	40,00 USD

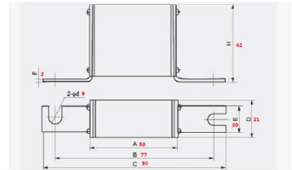

Sipariş Kodu	Boy	Voltaj (V)	Akım (A)	B.Fiyat
RS72B 690V 125A aR	31 D08	690V	125A	50,00 USD
RS72B 690V 160A aR	31 D08	690V	160A	50,00 USD
RS72B 690V 200A aR	31 D08	690V	200A	50,00 USD
RS72B 690V 250A aR	31 D08	690V	250A	50,00 USD
RS72B 690V 315A aR	31 D08	690V	315A	50,00 USD
RS72B 690V 350A aR	31 D08	690V	350A	50,00 USD
RS72B 690V 400A aR	31 D08	690V	400A	50,00 USD
RS72B 690V 450A aR	31 D08	690V	450A	55,00 USD
RS72B 690V 500A aR	31 D08	690V	500A	55,00 USD
RS72B 690V 550A aR	31 D08	690V	550A	55,00 USD
RS72B 690V 630A aR	31 D08	690V	630A	55,00 USD
RS73A 690V 450A aR	32 D08	690V	450A	55,00 USD
RS73A 690V 500A aR	32 D08	690V	500A	55,00 USD
RS73A 690V 550A aR	32 D08	690V	550A	55,00 USD
RS73A 690V 630A aR	32 D08	690V	630A	55,00 USD
RS73A 690V 700A aR	32 D08	690V	700A	90,00 USD
RS73A 690V 800A aR	32 D08	690V	800A	90,00 USD
RS73A 690V 900A aR	32 D08	690V	900A	90,00 USD
RS73A 690V 1000A aR	32 D08	690V	1000A	90,00 USD
RS74A 690V 630A aR	33 D08	690V	630A	90,00 USD
RS74A 690V 700A aR	33 D08	690V	700A	90,00 USD
RS74A 690V 800A aR	33 D08	690V	800A	105,00 USD
RS74A 690V 900A aR	33 D08	690V	900A	105,00 USD
RS74A 690V 1000A aR	33 D08	690V	1000A	105,00 USD
RS74A 690V 1250A aR	33 D08	690V	1250A	125,00 USD
RS74A 690V 1400A aR	33 D08	690V	1400A	125,00 USD
RS74A 690V 1500A aR	33 D08	690V	1500A	140,00 USD
RS74A 690V 1600A aR	33 D08	690V	1600A	165,00 USD

Teslimat Süreli



Table 2 (cont.)

Cat. No.	Modeli	Çapı	Rated voltage (V)	Rated current (A)	Dimensions (mm)	Weight (g)								
					Fg A B C D E F H									
0732	RS72B	A-160-08	690	200-400	7.7	44	76	108	50	25	6	66	10.5	300.5
0733	RS72C	A-160-08	690	215-430	7.7	44	108	140	50	25	6	66	10.5	303
0734	RS73A	A-160-08	690	200-400	7.7	44	76	108	50	25	6	78	10.5	327
0735	RS73B	A-160-08	690	215-430	7.7	44	108	140	50	25	6	78	10.5	351
0736	RS72B	A-160-08	690	200-400	7.7	44	76	108	50	25	6	78	10.5	300
0737	RS73A	A-160-08	690	200-400	7.7	44	76	108	50	25	6	66	10.5	281
0738	RS74B	A-160-08	690	300-600	7.7	44	108	140	50	25	6	90	12.5	360
0739	RS74C	A-160-08	690	315-630	7.7	44	140	172	50	25	6	90	12.5	384
0740	RS75A	A-160-08	690	300-600	7.7	44	108	140	50	25	6	78	12.5	330
0741	RS75B	A-160-08	690	315-630	7.7	44	140	172	50	25	6	78	12.5	354
0742	RS76A	A-160-08	690	400-800	7.7	44	108	140	50	25	6	90	12.5	360
0743	RS76C	A-160-08	690	420-840	7.7	44	140	172	50	25	6	90	12.5	384
0744	RS74B	A-160-08	690	300-600	7.7	44	108	140	50	25	6	90	12.5	360

Sipariş Kodu	Boy	Voltaj (V)	Akım (A)	B.Fiyat
RS71C 690V 550A aR	30 D11	690V	550A	85,00 USD
RS71C 690V 630A aR	30 D11	690V	630A	85,00 USD
RS72C 690V 125A aR	31 D11	690V	125A	65,00 USD
RS72C 690V 160A aR	31 D11	690V	160A	65,00 USD
RS72C 690V 200A aR	31 D11	690V	200A	65,00 USD
RS72C 690V 250A aR	31 D11	690V	250A	65,00 USD
RS72C 690V 315A aR	31 D11	690V	315A	69,00 USD
RS72C 690V 400A aR	31 D11	690V	400A	69,00 USD
RS72C 690V 450A aR	31 D11	690V	450A	69,00 USD
RS72C 690V 500A aR	31 D11	690V	500A	69,00 USD
RS72C 690V 550A aR	31 D11	690V	550A	69,00 USD
RS72C 690V 630A aR	31 D11	690V	630A	69,00 USD
RS72C 690V 700A aR	31 D11	690V	700A	95,00 USD
RS72C 690V 800A aR	31 D11	690V	800A	95,00 USD
RS73B 690V 450A aR	32 D11	690V	450A	102,00 USD
RS73B 690V 500A aR	32 D11	690V	500A	102,00 USD
RS73B 690V 630A aR	32 D11	690V	630A	102,00 USD
RS73B 690V 710A aR	32 D11	690V	710A	102,00 USD
RS73B 690V 800A aR	32 D11	690V	800A	102,00 USD
RS73B 690V 900A aR	32 D11	690V	900A	108,00 USD
RS73B 690V 1000A aR	32 D11	690V	1000A	108,00 USD
RS74B 690V 800A aR	33 D11	690V	800A	132,00 USD
RS74B 690V 900A aR	33 D11	690V	900A	132,00 USD
RS74B 690V 1000 A aR	33 D11	690V	1000A	135,00 USD
RS74B 690V 1100 A aR	33 D11	690V	1100A	135,00 USD
RS74B 690V 1250A aR	33 D11	690V	1250A	135,00 USD
RS74B 690V 1400A aR	33 D11	690V	1400A	135,00 USD
RS74B 690V 1500A aR	33 D11	690V	1500A	140,00 USD
RS74B 690V 1600A aR	33 D11	690V	1600A	165,00 USD



Table 3 (cont.)

Cat. No.	Modeli	Çapı	Rated voltage (V)	Rated current (A)	Dimensions (mm)	Weight (g)								
					Fg A B C D E F H									
0749	RS71C	A-160-11	690	550-1100	7.7	44	76	108	50	25	6	66	10.5	300.5
0750	RS71C	A-160-11	690	630-1260	7.7	44	108	140	50	25	6	66	10.5	324
0751	RS72C	A-160-11	690	200-400	7.7	44	76	108	50	25	6	78	10.5	327
0752	RS73B	A-160-11	690	215-430	7.7	44	108	140	50	25	6	78	10.5	351
0753	RS72C	A-160-11	690	200-400	7.7	44	76	108	50	25	6	66	10.5	281
0754	RS73B	A-160-11	690	200-400	7.7	44	76	108	50	25	6	66	10.5	281
0755	RS74B	A-160-11	690	300-600	7.7	44	108	140	50	25	6	90	12.5	360
0756	RS74C	A-160-11	690	315-630	7.7	44	140	172	50	25	6	90	12.5	384
0757	RS75B	A-160-11	690	300-600	7.7	44	108	140	50	25	6	78	12.5	330
0758	RS75C	A-160-11	690	315-630	7.7	44	140	172	50	25	6	78	12.5	354
0759	RS76B	A-160-11	690	400-800	7.7	44	108	140	50	25	6	90	12.5	360
0760	RS76C	A-160-11	690	420-840	7.7	44	140	172	50	25	6	90	12.5	384
0761	RS74B	A-160-11	690	300-600	7.7	44	108	140	50	25	6	90	12.5	360
0762	RS74C	A-160-11	690	315-630	7.7	44	140	172	50	25	6	90	12.5	384
0763	RS75B	A-160-11	690	300-600	7.7	44	108	140	50	25	6	78	12.5	330
0764	RS75C	A-160-11	690	315-630	7.7	44	140	172	50	25	6	78	12.5	354
0765	RS76B	A-160-11	690	400-800	7.7	44	108	140	50	25	6	90	12.5	360
0766	RS76C	A-160-11	690	420-840	7.7	44	140	172	50	25	6	90	12.5	384
0767	RS76B	A-160-11	690	400-800	7.7	44	108	140	50	25	6	90	12.5	360
0768	RS76C	A-160-11	690	420-840	7.7	44	140	172	50	25	6	90	12.5	384
0769	RS76B	A-160-11	690	400-800	7.7	44	108	140	50	25	6	90	12.5	360
0770	RS76C	A-160-11	690	420-840	7.7	44	140	172	50	25	6	90	12.5	384
0771	RS76B	A-160-11	690	400-800	7.7	44	108	140	50	25	6	90	12.5	360

Sipariş Kodu	Boy	Voltaj (V)	Akım (A)	B.Fiyat
RS75A 1000V 125A aR	70 D11	1000V	125A	120,00 USD
RS75A 1000V 250A aR	71 D11	1000V	250A	145,00 USD
RS75A 1000V 315A aR	71 D11	1000V	315A	145,00 USD
RS75A 1000V 450A aR	71 D11	1000V	450A	145,00 USD
RS75A 1000V 560A aR	71 D11	1000V	560A	195,00 USD
RS75B 1250V 500A aR	72 D11	1250V	500A	145,00 USD
RS75B 1250V 550A aR	72 D11	1250V	550A	145,00 USD
RS75B 1000V 630A aR	72 D11	1000V	630A	145,00 USD
RS75B 1250V 630A aR	72 D11	1250V	630A	145,00 USD
RS75B 1250V 800A aR	72 D11	1250V	800A	145,00 USD
RS75B 1000V 1000A aR	72 D11	1000V	1000A	165,00 USD
RS76C 1250V 630A aR	73 D11	1250V	630A	145,00 USD
RS76C 1000V 1000A aR	73 D11	1000V	1000A	185,00 USD
RS76C 1000V 1100A aR	73 D11	1000V	1100A	185,00 USD
RS76C 1250V 800A aR	73 D11	1250V	800A	185,00 USD
RS76C 1250V 900A aR	73 D11	1250V	900A	185,00 USD
RS76C 1250V 1000A aR	73 D11	1250V	1000A	185,00 USD
RS76C 1000V 1250A aR	73 D11	1000V	1250A	185,00 USD
RS76C 1100V 1400A aR	73 D11	1100V	1400A	220,00 USD



Table 4 (cont.)

Cat. No.	Modeli	Çapı	Rated voltage (V)	Rated current (A)	Dimensions (mm)	Weight (g)								
					Fg A B C D E F H									
0749	RS71C	A-160-11	690	550-1100	7.7	44	76	108	50	25	6	66	10.5	300.5
0750	RS71C	A-160-11	690	630-1260	7.7	44	108	140	50	25	6	66	10.5	324
0751	RS72C	A-160-11	690	200-400	7.7	44	76	108	50	25	6	78	10.5	327
0752	RS73B	A-160-11	690	215-430	7.7	44	108	140	50	25	6	78	10.5	351
0753	RS72C	A-160-11	690	200-400	7.7	44	76	108	50	25	6	66	10.5	281
0754	RS73B	A-160-11	690	200-400	7.7	44	76	108	50	25	6	66	10.5	281
0755	RS74B	A-160-11	690	300-600	7.7	44	108	140	50	25	6	90	12.5	360
0756	RS74C	A-160-11	690	315-630	7.7	44	140	172	50	25	6	90	12.5	384
0757	RS75B	A-160-11	690	300-600	7.7	44	108	140	50	25	6	78	12.5	330
0758	RS75C	A-160-11	690	315-630										

Sipariş Kodu	Boy	Voltaj (V)	Akım (A)	B.Fiyat
RS77A 690V 80A aR	30 TTF	690V	80A	45,00 USD
RS77A 690V 100A aR	30 TTF	690V	100A	45,00 USD
RS77A 690V 125A aR	30 TTF	690V	125A	45,00 USD
RS77A 690V 160A aR	30 TTF	690V	160A	45,00 USD
RS77A 690V 200A aR	30 TTF	690V	200A	45,00 USD
RS77A 690V 250A aR	30 TTF	690V	250A	45,00 USD
RS77 690V 250A aR	31 TTF	690V	250A	65,00 USD
RS77 690V 315A aR	31 TTF	690V	315A	65,00 USD
RS77 690V 350A aR	31 TTF	690V	350A	70,00 USD
RS77 690V 400A aR	31 TTF	690V	400A	70,00 USD
RS77 690V 450A aR	31 TTF	690V	450A	70,00 USD
RS77 690V 500A aR	31 TTF	690V	500A	70,00 USD
RS77 690V 550A aR	31 TTF	690V	550A	65,00 USD
RS77 690V 630A aR	31 TTF	690V	630A	65,00 USD
RS77 690V 700A aR	31 TTF	690V	700A	65,00 USD
RS77 690V 800A aR	31 TTF	690V	800A	89,00 USD
RS77B 690V 500A aR	32 TTF	690V	500A	75,00 USD
RS77B 690V 630A aR	32 TTF	690V	630A	75,00 USD
RS77B 690V 700A aR	32 TTF	690V	700A	75,00 USD
RS77B 690V 800A aR	32 TTF	690V	800A	75,00 USD
RS77B 690V 900A aR	32 TTF	690V	900A	80,00 USD
RS77C 690V 630A aR	33 TTF	690V	630A	110,00 USD
RS77C 690V 700A aR	33 TTF	690V	700A	110,00 USD
RS77C 690V 800A aR	33 TTF	690V	800A	110,00 USD
RS77C 690V 900A aR	33 TTF	690V	900A	110,00 USD
RS77C 690V 1000A aR	33 TTF	690V	1000A	135,00 USD
RS77C 690V 1100A aR	33 TTF	690V	1100A	155,00 USD
RS77C 690V 1250A aR	33 TTF	690V	1250A	155,00 USD
RS77C 690V 1400A aR	33 TTF	690V	1400A	160,00 USD
RS77C 690V 1500A aR	33 TTF	690V	1500A	160,00 USD
RS77C 690V 1600A aR	33 TTF	690V	1600A	170,00 USD
RS77CB 690V 1600A aR	33TTF	690V	1600A	170,00 USD
RS77C 690V 1800A aR	33 TTF	690V	1800A	170,00 USD
RS77C 690V 2000A aR	33 TTF	690V	2000A	190,00 USD



Table 7 (cont.)

Cat. No.	Models MIRO	Cross-reference	Rated voltage (V)	Rated current (A)	Dimensions/sizes (mm)	Weight (g)					
					Fig. A	C	D	H	md		
0740	RS550	-	2000	550	7.10	130	136	73	13	1960	
0741	NGT3M	-	3300/3300	330-530	7.10	67	76	87	85	12	910
0742	RS77	A1-66C-TS	660	200-400	7.10	42	51	61	60	8	354
0743	RS77A	A2-66C-TS	660	80-160	7.10	42	51	40	58	8	225
0744	RS77B	A2-66C-TS	660	400-830	7.10	42	51	60	78	10	518
0745	RS77C	A2-66C-TS	660	830-1000	7.10	45	54	74	92	12	865
0746	RS77H	-	1000	200-400	7.10	66	76	50	66	8	528
0747	RS78	3ME43.68	660	315-500	7.10	66	77	60	77	10	860
0748	RS79	-	1000	400-1000	7.10	92	106	74	92	12	1655
0749	RS79A	170M34	660	200-400	7.10	46	52	43	61	8	277
0750	RS79C	-	1000	400-1000	7.10	77	85	74	92	12	1325
0751	RS79D	140M63	1000	800-1000	7.10	67	75	74	92	12	1170
0752	RS79E	170M64	1000	830-1000	7.10	87	95	74	92	12	1400
0753	RS550Z	-	2000	550	7.10	135	143	74	92	12	1885
0754	RS82	CS5F	500	75-200	7.10	40	47	47	70	8	325
0755	RS83	CS5F	500	200-400	7.10	43	51	57	82	8	450
0756	RS84	CS5F	500	450-830	7.10	42	53	72	92	10	830
0757	RS85	CS10F	500	200-500	7.10	66	76	60	77	10	740
0758	RS86	3ME64	500	300-700	7.10	66	77	72	92	10	1110
0759	RS86A(Z)	RSF-4	500/800	800-1250	7.10	68	78	85	130	12	1200
0760	RS87	RSF-6	500/1000	1250-1600/7.10	70	80	105	150	16	1320	
0761	RS87A(Z)	RSF-6	800/1000	1600-2000/7.10	81	91	120	165	16	2216	
0762	RS88A	-	660	800-1600	7.10	78	90	105	127	16	1240

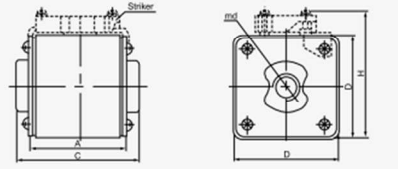

Z300586 Mersen
170M6469 - 170M6419 Bussmann

1000V - 1300V aR Vidalı Hızlı Yarı iletken Koruma Sigortalar

Sipariş Kodu	Boy	Voltaj (V)	Akım (A)	B.Fiyat
RS77H 1000V 250A aR	71 TTF	1000V	250A	68,00 USD
RS77H 1300V 200A aR	71 TTF	1300V	200A	68,00 USD
RS77H 1300V 250A aR	71 TTF	1300V	250A	68,00 USD
RS77H 1300V 315A aR	71 TTF	1300V	315A	68,00 USD
RS77H 1300V 400A aR	71 TTF	1300V	400A	68,00 USD
RS85 1000V 630A aR	72 TTF	1000V	630A	95,00 USD
RS85 1000V 800A aR	72 TTF	1000V	800A	105,00 USD
RS79D 1000V 630A aR	73 TTF	1000V	630A	148,00 USD
RS79D 1000V 700A aR	73 TTF	1000V	700A	148,00 USD
RS79D 1000V 800A aR	73 TTF	1000V	800A	148,00 USD
RS79D 1000V 900A aR	73 TTF	1000V	900A	148,00 USD
RS79D 1000V 1000A aR	73 TTF	1000V	1000A	148,00 USD
RS79D 1000V 1100A aR	73 TTF	1000V	1100A	155,00 USD
RS79D 1000V 1250A aR	73 TTF	1000V	1250A	155,00 USD
RS79D 1000V 1400A aR	73 TTF	1000V	1400A	175,00 USD
RS87 1000V 1600A aR	RSF.6	1000V	1600A	350,00 USD



Table 7 (cont.)

Cat. No.	Models MIRO	Cross-reference	Rated voltage (V)	Rated current (A)	Dimensions/sizes (mm)	Weight (g)					
					Fig. A	C	D	H	md		
0740	RS550	-	2000	550	7.10	130	136	73	13	1960	
0741	NGT3M	-	3300/3300	330-530	7.10	67	76	87	85	12	910
0742	RS77	A1-66C-TS	660	200-400	7.10	42	51	61	60	8	354
0743	RS77A	A2-66C-TS	660	80-160	7.10	42	51	40	58	8	225
0744	RS77B	A2-66C-TS	660	400-830	7.10	42	51	60	78	10	518
0745	RS77C	A2-66C-TS	660	830-1000	7.10	45	54	74	92	12	865
0746	RS77H	-	1000	200-400	7.10	66	76	50	66	8	528
0747	RS78	3ME43.68	660	315-500	7.10	66	77	60	77	10	860
0748	RS79	-	1000	400-1000	7.10	92	106	74	92	12	1655
0749	RS79A	170M34	660	200-400	7.10	46	52	43	61	8	277
0750	RS79C	-	1000	400-1000	7.10	77	85	74	92	12	1325
0751	RS79D	140M63	1000	800-1000	7.10	67	75	74	92	12	1170
0752	RS79E	170M64	1000	830-1000	7.10	87	95	74	92	12	1400
0753	RS550Z	-	2000	550	7.10	135	143	74	92	12	1885
0754	RS82	CS5F	500	75-200	7.10	40	47	47	70	8	325
0755	RS83	CS5F	500	200-400	7.10	43	51	57	82	8	450
0756	RS84	CS5F	500	450-830	7.10	42	53	72	92	10	830
0757	RS85	CS10F	500	200-500	7.10	66	76	60	77	10	740
0758	RS86	3ME64	500	300-700	7.10	66	77	72	92	10	1110
0759	RS86A(Z)	RSF-4	500/800	800-1250	7.10	68	78	85	130	12	1200
0760	RS87	RSF-6	500/1000	1250-1600/7.10	70	80	105	150	16	1320	
0761	RS87A(Z)	RSF-6	800/1000	1600-2000/7.10	81	91	120	165	16	2216	
0762	RS88A	-	660	800-1600	7.10	78	90	105	127	16	1240

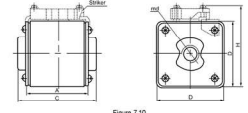

RS87 Ölçüler: A 70 / C 80 / D 105 / H 150 M16

Special aR Vidalı Yarı iletken Koruma Sigortalar

Sipariş Kodu	Boy	Voltaj (V)	Akım (A)	B.Fiyat
RSQ4 690V 1250A	4 TTF/4xM10	690V	1250A	270,00 USD
RSQ4 690V 2000A	4 TTF/4xM10	690V	2000A	270,00 USD
RSQ4 690V 2500A	4 TTF/4xM10	690V	2500A	270,00 USD
RSQ3 800V 2000A	3 TTF/2xM10	800V	2000A	260,00 USD
RS76B 690V 630A	110/LLE	690V	630A	180,00 USD



Special aR Kancalı Yarı iletken Koruma Sigortalar

Sipariş Kodu	Boy	Voltaj (V)	Akım (A)	B.Fiyat
BRS86242 750V DC 125A	CC 7,5 gRC/120EF	750V DC	125A	240,00 USD
BD2-125A 1200VDCBB	Size 70 aR Tabana Montaj L Bracket	1200V DC	125A	450,00 USD
BD2-80A 1200VDCBB	Size 70 aR Tabana Montaj L Bracket	1200V DC	80A	450,00 USD



1 BOY 1000VAC Alman Tipi Special Kancalı Yarı iletken Sigortalar DIN 110

Sipariş Kodu	Boy	Voltaj (V)	Akım (A)	B.Fiyat
NGT1Q 1000VAC 125A	Size 71 D11	1000V AC	125A	90,00 USD
NGT1Q 1000VAC 160A	Size 71 D11	1000V AC	160A	90,00 USD
NGT1Q 1000VAC 200A	Size 71 D11	1000V AC	200A	90,00 USD
NGT1Q 1000VAC 250A	Size 71 D11	1000V AC	250A	90,00 USD



Silindirik Sigorta Yuvaları 10x38 mm

Sipariş Kodu	Boy	Voltaj (V)	Akım (A)	B.Fiyat
RT18-32 1P	10x38 1P	690V	32A	5,00 USD
RT18-32 2P	10x38 2P	690V	32A	10,00 USD
RT18-32 3P	10x38 3P	690V	32A	15,00 USD
RT18-32 2x1P (LEDLİ IŞIKLI)	10x38 1P	690V	32A	15,00 USD

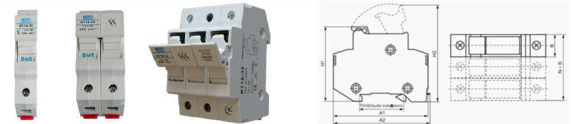

MRO BOR Silindirik Sigorta Yuvaları 14x51 mm

Sipariş Kodu	Boy	Voltaj (V)	Akım (A)	B.Fiyat
RT18L-63 1P	14x51 1P	690V	63A	10,00 USD
RT18L-63 2P	14x51 2P	690V	63A	20,00 USD
RT18L-63 3P	14x51 3P	690V	63A	25,00 USD
RT18L-63x1P (LEDLİ,ŞIKLI)	14x51 1P	690V	63A	35,00 USD



MRO BOR Class J Time Delay

Sipariş Kodu	Voltaj (V)	Akım (A)	B.Fiyat
BJT 15A	600V	AJT15	60,00 USD
BJT 80A	600V	AJT80	135,00 USD



MRO BOR Silindirik Sigorta Yuvaları 22x58 mm

Sipariş Kodu	Boy	Voltaj (V)	Akım (A)	B.Fiyat
RT18L-125 1P	22x58 1P	690V	125A	15,00 USD
RT18L-125 2P	22x58 2P	690V	125A	30,00 USD
RT18L-125 3P	22x58 3P	690V	125A	35,00 USD



MRO BOR Class CC Time Delay

Sipariş Kodu	Boy	Voltaj (V)	Akım (A)	B.Fiyat
RO15T	ATDR	600V	10A	65,00 USD
RO15T	ATDR	600V	12A	65,00 USD
RO15T	ATDR	600V	20A	65,00 USD
RO15T	ATDR	600V	25A	65,00 USD
RO15T	ATDR	600V	30A	65,00 USD



MRO BOR L Bracket Yere Montaj Sigorta Kaideleri 80 mm - 110 mm

Sipariş Kodu	Boy	Voltaj (V)	Akım (A)	B.Fiyat
FB11C	80 mm	690V	400A	18,50 USD
Alman tipi kancalı Sigorta Kaide				
FB73B	110 mm	700V	630A	90,00 USD
BFM110	80-110mm	1300V AC	1400 A	125,00 USD
	80-110mm	700V AC	2000 A	



MRO BOR Ölçü Aleti Sigortaları

Sipariş Kodu	B.Fiyat
BC10 440mA 1000V DC DMM44/100	55,00 USD
BC10 11A 1000V DC DMB11A	55,00 USD



MRO BOR Amerika Tipi Sigortalar - BWP AC 700V: 75-600A

Sipariş Kodu	Boy	Voltaj (V)	Akım (A)	B.Fiyat
BWP-75A aR	L: 11,50 CM	AC 700V - DC 500V	75A	40,00 USD
BWP-100A aR	L: 11,50 CM	AC 700V - DC 500V	100A	40,00 USD
BWP-125A aR	L: 13 CM	AC 700V - DC 500V	125A	50,00 USD
BWP-150A aR	L: 13 CM	AC 700V - DC 500V	150A	50,00 USD
BWP-180A aR	L: 13 CM	AC 700V - DC 500V	180A	50,00 USD
BWP-200A aR	L: 13 CM	AC 700V - DC 500V	200A	50,00 USD
BWP-450A aR	L: 18 CM	AC 700V - DC 500V	450A	110,00 USD
BWP-600A aR	L: 18 CM	AC 700V - DC 500V	600A	110,00 USD



MRO BOR Yatay Sigorta Yük Ayırıcılar

Sipariş Kodu	Boy	B.Fiyat
BHR17-160 3P	NH00 160A 3P	27,00 USD
DR1-160 3P	NH00 160A 3P	30,00 USD
DR1-250 3P	NH1 250A 3P	68,00 USD
DR1-400 3P	NH2 400A 3P	89,00 USD
DR1-630 3P	NH3 630A 3P	126,00 USD

(Ekonomik Model)



MRO BOR Micro Switch

Sipariş Kodu	B.Fiyat
RS77ZX TABAN MONTAJ SWITCH	16,00 USD
TYPE MICRO SWITCH+ADAPTOR FOR RS77	13,00 USD



MRO BOR Ellik Tutucu

Sipariş Kodu	B.Fiyat
1401 NT 000-4 Ellik	15,00 USD



MRO BOR Forklift Sigortalar DC 48V

Sipariş Kodu	Boy	Voltaj (V)	Akım (A)	B.Fiyat
CNL-35/Q 8.7	CNL-35	48V	35A	10,00 USD
CNL-50/Q 8.7	CNL-50	48V	50A	10,00 USD
CNL-60/Q 8.7	CNL-60	48V	60A	10,00 USD
CNL-80/Q 8.7	CNL-80	48V	80A	10,00 USD
CNL-100/Q 8.7	CNL-100	48V	100A	10,00 USD
CNL-125/Q 8.7	CNL-125	48V	125A	10,00 USD
CNL-150/Q 8.7	CNL-150	48V	150A	10,00 USD
CNL-175/Q 8.7	CNL-175	48V	175A	10,00 USD
CNL-200/Q 8.7	CNL-200	48V	200A	10,00 USD
CNL-250/Q 8.7	CNL-250	48V	250A	10,00 USD
CNL-300/Q 8.7	CNL-300	48V	300A	15,00 USD
CNL-350/Q 8.7	CNL-350	48V	350A	15,00 USD
CNL-400/Q 8.7	CNL-400	48V	400A	15,00 USD
CNL-500/Q 8.7	CNL-500	48V	500A	15,00 USD
CNL-600/Q8.7	CNL-600	48V	600A	15,00 USD
BXR1 Forklift Sigorta Kaide	DC-24-72V /220 AC		35-800A	14,00 USD

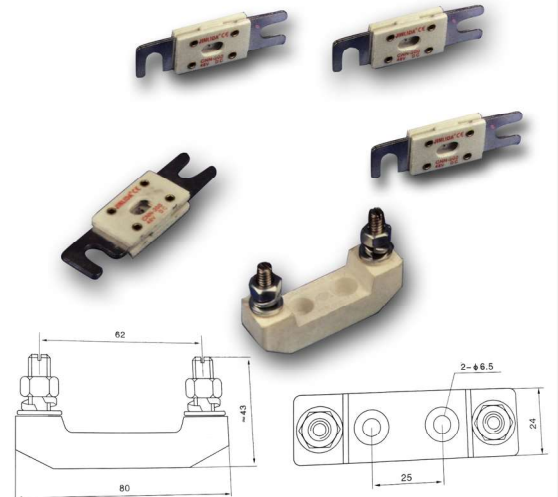



MİRO BOR

1000V 10x38 gPV Fotovoltik Sigortalar

Sipariş Kodu	Boy	Voltaj (V)	Akım (A)	B.Fiyat
PV10 gPV DC 1000V 2A	10x38	PV 1000V	2A	4,00 USD
PV10 gPV DC 1000V 4A	10x38	PV 1000V	4A	4,00 USD
PV10 gPV DC 1000V 6A	10x38	PV 1000V	6A	4,00 USD
PV10 gPV DC 1000V 10A	10x38	PV 1000V	10A	4,00 USD
PV10 gPV DC 1000V 15A	10x38	PV 1000V	15A	4,00 USD
PV10 gPV DC 1000V 20A	10x38	PV 1000V	20A	5,00 USD
PV10 gPV DC 1000V 25A	10x38	PV 1000V	25A	5,00 USD
PV10 gPV DC 1000V 30A	10x38	PV 1000V	30A	8,00 USD



MİRO BOR

1500V 10x85 gPV Fotovoltik Sigortalar

Sipariş Kodu	Boy	Voltaj (V)	Akım (A)	B.Fiyat
BS385-PV gpV	10x85	PV 1500V	2A	22,00 USD
BS385-PV gpV	10x85	PV 1500V	4A	22,00 USD
BS385-PV gpV	10x85	PV 1500V	6A	22,00 USD
BS385-PV gpV	10x85	PV 1500V	10A	22,00 USD
BS385-PV gpV	10x85	PV 1500V	15A	22,00 USD
BS385-PV gpV	10x85	PV 1500V	20A	22,00 USD
BS385-PV gpV	10x85	PV 1500V	25A	25,00 USD
BS385-PV gpV	10x85	PV 1500V	30A	25,00 USD



MİRO BOR

1000V 14x51 gPV Fotovoltik Silindirik Sigortalar

Sipariş Kodu	Boy	Voltaj (V)	Akım (A)	B.Fiyat
BS314-PV gPV 15A	14X51	PV1000V	15A	9,50 USD
BS314-PV gPV 20A	14X51	PV1000V	20A	9,50 USD
BS314-PV gPV 32A	14X51	PV1000V	32A	9,50 USD
BS314-PV gPV 40A	14X51	PV1000V	40A	9,50 USD
BS314-PV gPV 50A	14X51	PV1000V	50A	9,50 USD
BS314-PV gPV 63A	14X51	PV1000V	63A	12,00 USD



MİRO BOR

1000V 10x38 gPV Fotovoltik Silindirik Sigorta Kaideleri

Sipariş Kodu	Boy	Voltaj (V)	Akım (A)	B.Fiyat
PVH 30-1	10X38 1P	PV1000V DC	30A	8,00 USD
PVH 30-2	10X38 2P	PV1000V DC	30A	17,00 USD



MİRO BOR

1500V 10x85 gPV Fotovoltik Silindirik Sigorta Kaideleri

Sipariş Kodu	Boy	Voltaj (V)	Akım (A)	B.Fiyat
BH.385.PV	10X85	PV1500V	30A	25,00 USD



MİRO BOR

1000V 14x51 gPV Fotovoltik Silindirik Sigorta Kaideleri

Sipariş Kodu	Boy	Voltaj (V)	Akım (A)	B.Fiyat
BH.314.PV1	14X51 1P	PV1000V	63A	25,00 USD



MİRO BOR

NH1 gPV 1000V Fotovoltik Sigortalar

Sipariş Kodu	Boy	Voltaj (V)	Akım (A)	B.Fiyat
BPV.300.NH1 gPV 50A	NH1	PV1000V	50A	65,00 USD
BPV.300.NH1 gPV 63A	NH1	PV1000V	63A	65,00 USD
BPV.300.NH1 gPV 125A	NH1	PV1000V	125A	75,00 USD
BPV.300.NH1 gPV 160A	NH1	PV1000V	160A	75,00 USD
BPV.300.NH1 gPV 200A	NH1	PV1000V	200A	75,00 USD



MİRO BOR

1000V-1500V NH1L Fotovoltik Fuse Holder

Sipariş Kodu	Voltaj (V)	Akım (A)	B.Fiyat
BH.300.NH1L	PV1000V	FUSE HOLDER	60,00 USD
BH.315.NH3L	PV1500V	FUSE HOLDER	97,00 USD



MİRO BOR

NH3L gPV Fotovoltik Sigortalar

Sipariş Kodu	Boy	Voltaj (V)	Akım (A)	B.Fiyat
BPV.315.250A	NH3L	PV1500V	250A	145,00 USD
BPV.315.315A	NH3L	PV1500V	315A	145,00 USD
BPV.315.400A	NH3L	PV1500V	400A	165,00 USD
BPV.315.450A	NH3L	PV1500V	450A	165,00 USD
BPV.315.500A	NH3L	PV1500V	500A	185,00 USD
BPV.315.630A	NH3L	PV1500V	630A	210,00 USD



- Fatura kesim tarihindeki TCMB efektif satış kuru üzerinden Türk Lirasına çevrilecektir.
- Fiyatlarımıza KDV dahil değildir.
- Bor Endüstri Elektrik Elektronik Tic.A.Ş. fiyat listesinden haber vermeksizin değişiklik yapma hakkına sahiptir.

BD Serisi (DC Sigorta)



Ratings:

Voltage Rating: 750V-4200V

Current Rating: 20A-2000A

Interrupt Rating: 30 kA- 100 kA

Ordering Information:

BDXXX- XXX A XXX V XX

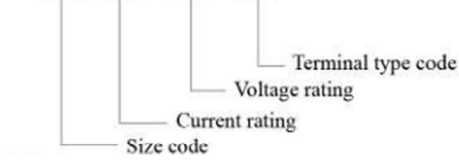

Notes:

While terminal type is optional, the terminal type code should be indicated immediately behind the voltage rating, and the D11 type is default;

Indicator is K for type K indicator (default), etc.

While gR/aR are optional, aR is default and gR should follow the indicator code,







Eg. BD0-BD1-BD2-BD3 1200V FS-V-gR

If need other type indicator, please contact us.

While microswitch is necessary, the terminal type code should be followed by "M"

Eg. BD1-2000A 1200V FSM-K-gR
2xBD2-2xBD3

Terminal type code	Terminal type
FS	Terminal FS
D11	Terminal D11
FB	Terminal FB
AB	Terminal AB
BB	Terminal BB
D08	Terminal D08

Size code	Maximum cross section size of body	
0	45×45	
1	53×53	
2	68×68	
3	76×76	
4	85×85	
5	118×118	

Semiconductors IGBT Protection Fuse



Ratings:

Voltage Rating: 1000V AC

1000V DC

Current Rating: 25A-500A

Interrupt Rating: 50 kA- 100 kA

Mechanical Dimensions:

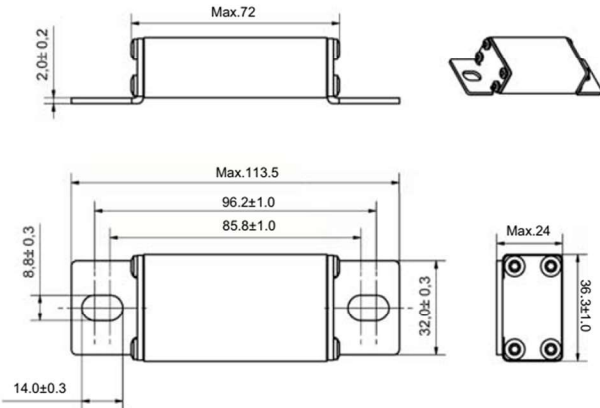

BDR Serisi 1000VDC

Metro 3. Ray Sigortası



Ratings:

Voltage Rating: 1000VDC

Current Rating: 400A-1000A

Interrupt Rating: 30 kA

Mechanical Dimensions:

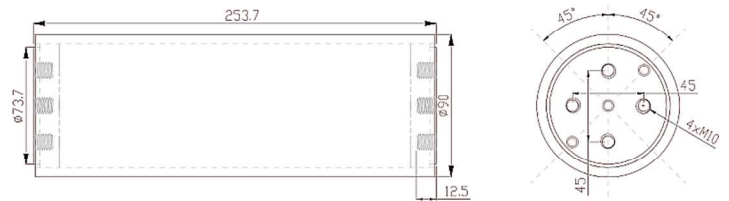



Sigorta Çeşitleri

Hızlı Sigortalar

Özel Amaçlı Sigortalar

Sigorta Tutucuları ve Kartuşları

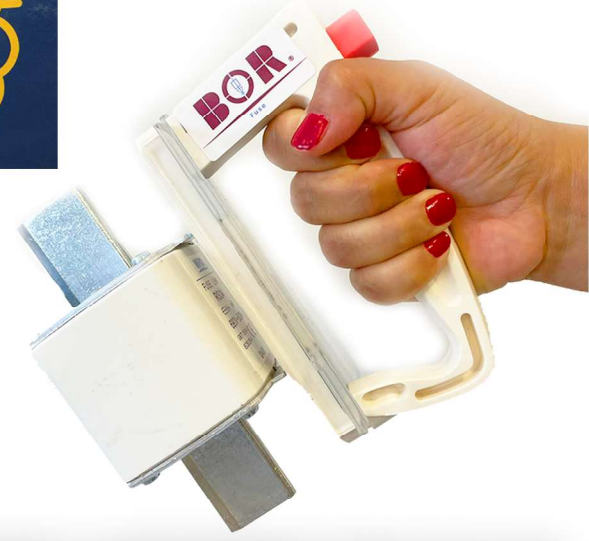

NH BİÇAKLI SİGORTA DEĞİŞTİRME CİHAZI (ELLİK)
Fuses NH Sigorta Ellik NT

NH000-NH00, NH0-NH3 ve NH4 sigortaları için
üç korumalı tutucu delikleri mevcuttur.

- Güvenli yalıtım
- Güvenli ve rahat kullanım
- Küçük manuel güç gereksinimleri
- 1000V'a kadar anma izolasyon gerilimi
- Çalışma frekansı 50Hz AC



STOK



BHR17-160 3P
Yatay Sigorta Yük
Ayırıcı Ekonomik Model

Profesyonel Üretim

AGV Mobil Makineler

Robotik Sistemler

Proses Kontrol

Asansör Endüstriyel Kapılar

Fabrika Otomasyonu

Raylı Sistemler
(Metro ve Tramvay)

Petro Kimya

Petrol-Gaz-Maden

Elektrik Motorları

Rüzgar Enerjisi

Güneş Enerjisi

Enerji Yönetimi

Daha Fazlası İçin Ürünlerimizi
www.borelektronikshop.com.tr
ziyaret edebilirsiniz.

Merkez/Head Office (Karaköy)

Evliya Çelebi Mah. Meşrutiyet Cad.
Nur Apt. No:98 Kat: 4 Daire 11
34430 Beyoğlu İSTANBUL
Tel: +90 212 238 08 50
Faks: +90 212 238 08 51
info@borelektronik.com.tr
www.borelektronik.com.tr

Lojistik/Sevkiyat – Logitics/Shipment (Tuzla)

Aydınlı Mah.Üniversite Cad. Melodi Sok
Bilmo Sanayi Sitesi No:2/30 Kat:2 34953
Tuzla İSTANBUL

Ofis / Office

Elisabethstraße 6
53859
Niederkassel, GERNANY



2026